

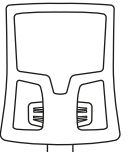

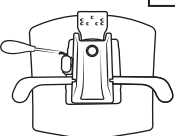



1690 SYN SL NEW PURE

A	 1x	B	 1x	C	 1x	D	 1x	E	G	 3x	 1x
PDH		APPLIES TO VERSION WITH PDH/WITHOUT PDH									
F	H										
										 3x	 5x

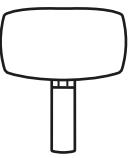

1690 SYN SL NEW PURE

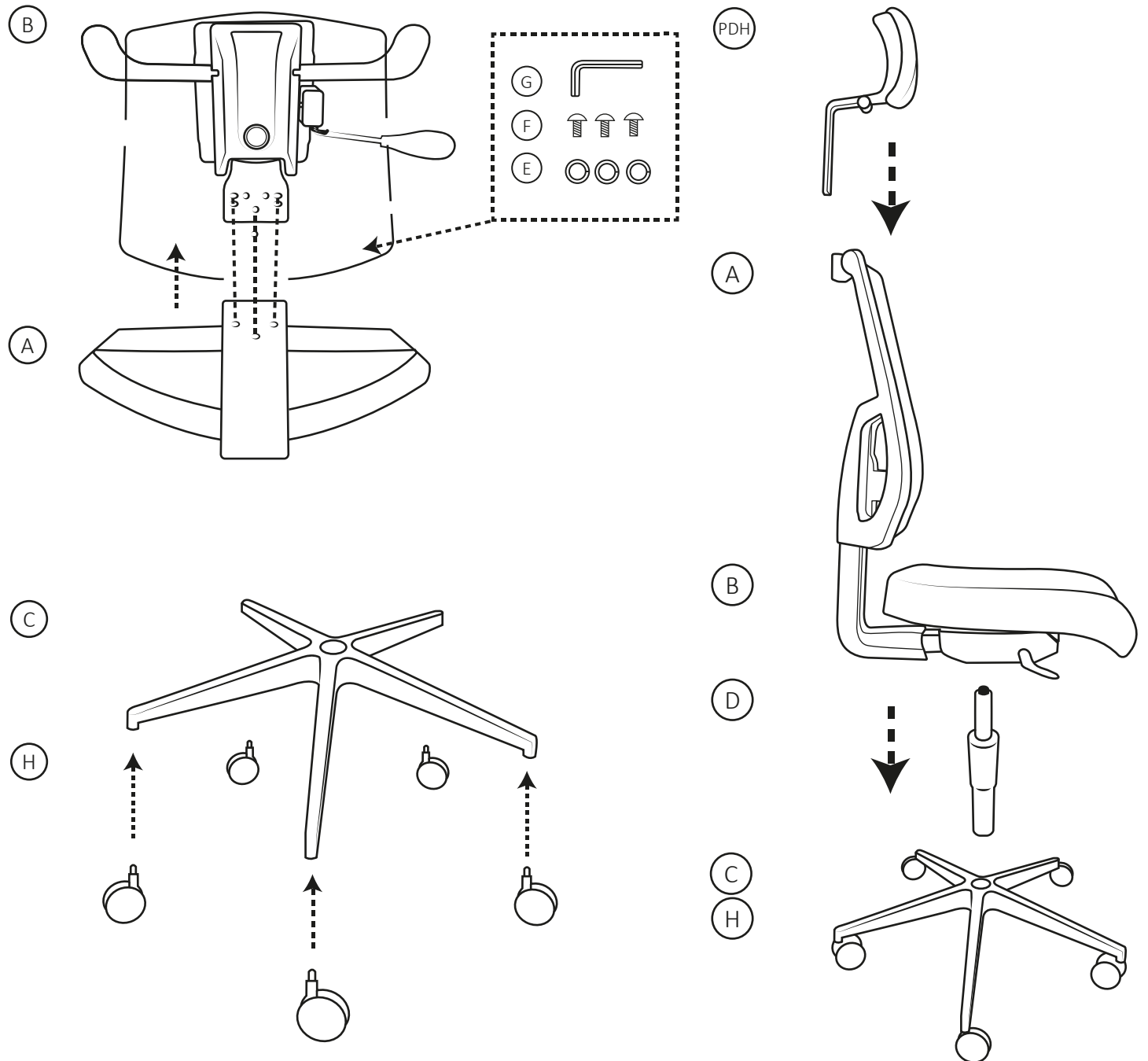
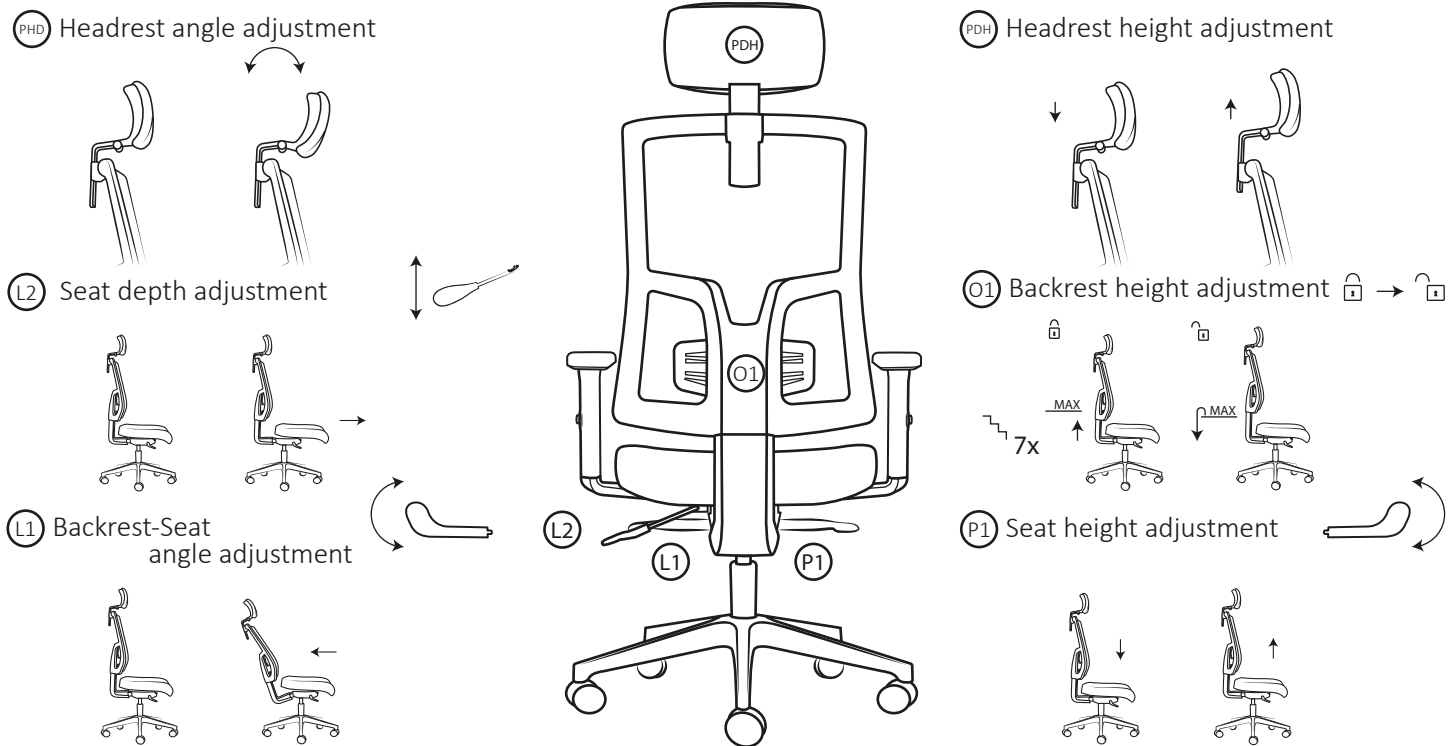

MAINTENANCE

Maintenance of upholstery is carried out by wiping off dirt and spots with a damp cloth; in case of leather or leatherette please use a slightly watery cloth.

Warranty period is 60 months. During the warranty period, the manufacturer will replace free of charge all parts that have been damaged due to material defects or manufacturing errors. In these cases, the manufacturer replaces defective parts, not the entire chair.

The warranty does not cover damages caused by:

1. Transportation (damages are the responsibility of the carrier)
2. Natural disasters
3. Incorrect assembly
4. Careless and inappropriate use
5. Non-compliance with the provided instructions

An overview of the upholstery materials used, including their composition, is provided in the attached information sheet, which forms part of the product documentation or alternatively at <https://www.antares.cz/textilie>.

The product complies with the requirements of the ČSN EN 1335-1+A1:2023 standard, and based on measurements, it is classified as a Type B chair. **WARNING:** The gas lift is under constant pressure and must not be disassembled. Risk of injury! The product is equipped with casters for soft floors (e.g., carpets). Optional casters with a rubber tread are intended for hard floors (e.g., tiles, laminate, vinyl, etc.). These casters are more floor-friendly and reduce rolling noise. When used in dusty environments, a protective floor mat is recommended. This helps to prevent abrasive wear and damage to the surface under the workstation.

